

7" Recording Monitor DVR

Operation Manual

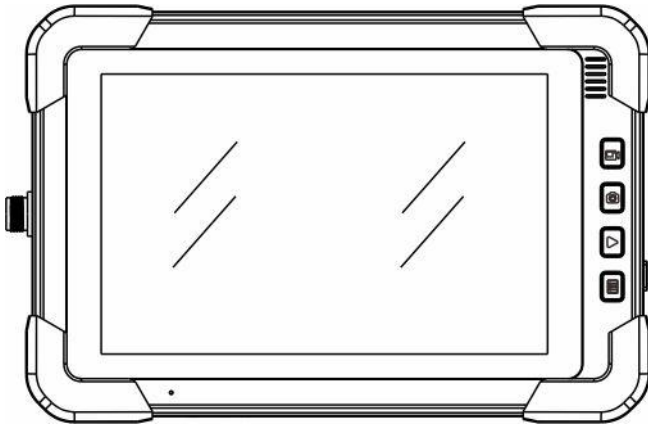

Menu

Product Overview	4
Product Recognition.....	5,6
Button Operation.....	7
Screen Touch.....	8-10
System Setting.....	11,12
RoadCam App	13
APP Monitoring Interface.....	14
Charge/ Firmware upgrade/Attention.....	15
Data Port Pin Definition.....	16
Specifications.....	17-18
RoadCam App Download.....	18

Product Overview

The 4K HD Touch Tablet Monitor, capable of taking high-resolution images at up to 12MP and recording 4K video. Expertly designed for synchronization, it supports both AHD and CVBS video inputs, ensuring audio and video alignment for a seamless experience. The user can operate it through screen touch or body buttons. This monitor adopts a 7-inch HD touch screen and a waterproof & dust-proof design. 4 protective corners can properly protect machine. Adjustable wrist belt design is easy to hold. In addition, the battery can be disassembled to support separate charging. It can work with a wide range of remote cameras with customization functions (like 360°PTZ, GPS coordinates, measure). It is convenient to use in different fields.

Product Recognition

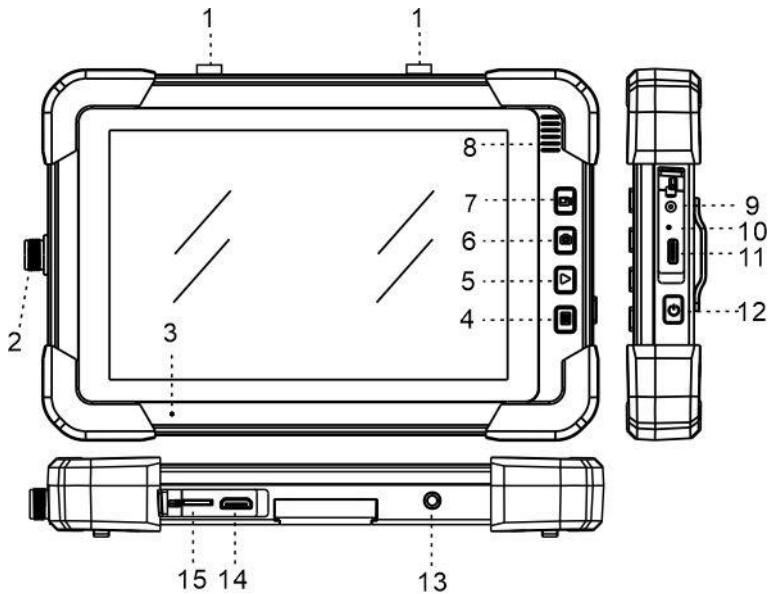

- | | |
|---------------------------|---------------------------|
| 1, 4G Antenna (Not ready) | 2, M12 aviation Connector |
| 3, Microphone | 4, Menu/Confirm |
| 5, Play/Return | 6, Photo/ Back |
| 7, Record/Forward | 8, Speaker |
| 9, DC12V | 10, LED Control |
| 11, Type-C | 12, ON-OFF |
| 13, Headset | 14, HDMI Output |
| 15, Micro SD Card | |

Product Recognition

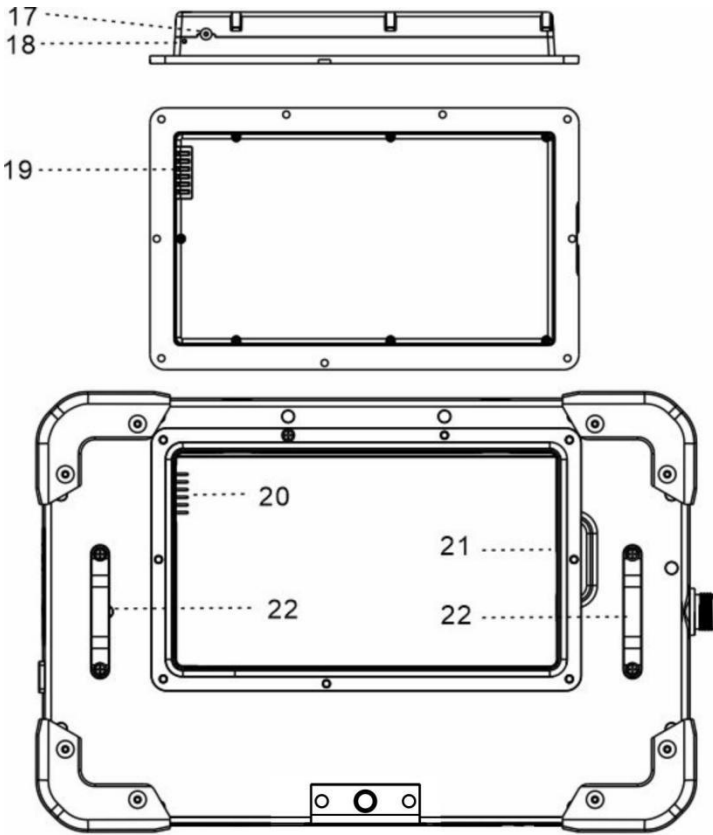

17, Battery charge port

18, Charging indicator

19, Battery connector

20, Battery connector

21, 4G Card Slot

22, Wrist strap socket

Button Operation

-  **ON-OFF**

Press briefly to power on. Press it for 3s to power off. If crash, press it for 10s to power off and reset.

-  **Photo**

Press briefly, flashes once and get a photo.

-  **Record**



Press briefly to record, and the icon turns blue. The video timer can time. Press again to end.

-  **Playback/Return**





Press  to enter review photos and videos.

Press  or  to select.

Press  to confirm. Press  Play again to exit

When record, press  to pause and stop timing; press  again to restore.

-  **Menu/Confirm**

Press it briefly to enter. Press Press  or  to select. Press  to confirm. Press  Play to exit.

Touch Screen

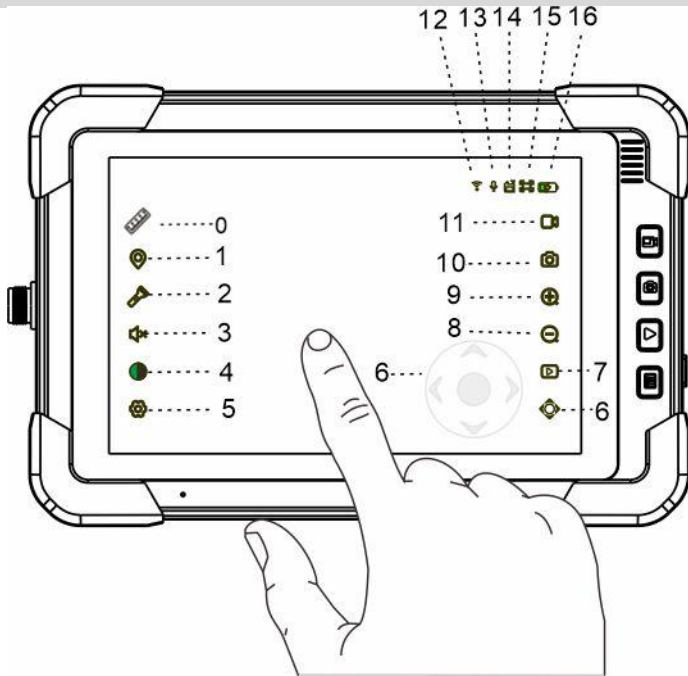

0.Range Measurement (Unavailable on this machine)

1.Mark

 : Pop up keyboard to input mark, which will display in the lower left corner. Touch it to revise or delete.

2.LED Brightness Control

 : Move the slider to control cam' s LED brightness.

3.Speaker Volume Control

 : Move the slider to control the speaker volume.

Touch Screen

4.Display Parameter Adjustment.

 : Move the sliding block to adjust the parameter.

 : Brightness

 : Contrast

 : Colourity

 : Saturation

5.System Setup

 : Touch this to enter into system setup.



6.Pan Tilt Control

click  : enter into or exit the control mode.

click  ,pop up the pan tilt control interface  ,

touch the up, down, left, and right icons to control the pan tilt camera to rotate up, down, left, and right. The camera stops rotating when leaving the up, down, left, right icons.

7.Play

 : Play photo & video. Touch  to lock the important ones in case error deletion. Touch again to unlock it.

8.Zoom out

 : Touch this to zoom out the screen.

Touch Screen

9. Zoom in

: Touch this to zoom in the screen.

10.. Photo

: Touch to take photo and screen flashes once.

11. Reco

 Touch it, the icon turns blue, and the video timer starts; touch it again to end.

12. WiFi

 : WiFi is on; if crossed, WiFi is off.

13. Mic

 : Mic. is on. If crossed, Mic. is off.

14. Micro SD card

: Card is ok. If crossed, abnormal or no card.

15. Icon Switching of Image Display Scale

Press : Image displays **4: 3**

Press : Image displays **16: 9**

16. Battery power

: Display battery power: the lighting shows it' s charging.

System Setup

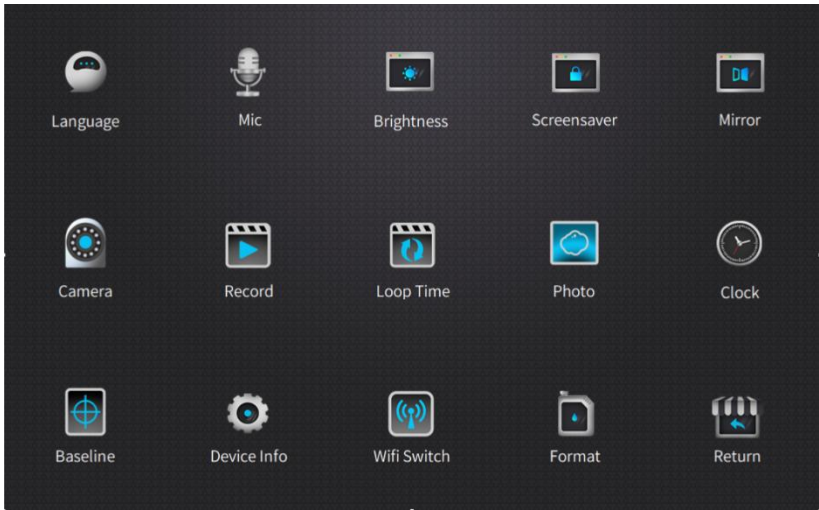

Language Show the available languages: Chinese, Traditional Chinese, English, French, German, Russian, Korean, Japanese.

Mic. Touch to turn the microphone on/off.

Brightness Touch to set the screen brightness.

Screensaver Touch to set the time of screen Saver

Mirror Touch to set: normal display; flip horizontal; flip vertical; flip horizontal & vertical.

Camera Touch to set camera input resolution. According to the resolution & frame rate of the known AHD camera, you can choose: Auto 4K,2K, 1080P, 720P, CVBS. Monitor will reset after switching the resolution.

Record Touch to set resolution of recording.

System Setup

Loop Time Touch to set the time of recycle recording: 1s, 5s, 10s, 20s 30s, off. If choose 'off' , recording will end until the micro SD card is full.

Photo Touch to set the size of photo: 12M, 8M, 4M 2M pixels.

Clock Touch to set the system date & time.

Baseline Touch to set the types of baseline: off; cross; ruler; roundel.

Device Info. *About, Reset and Password Switch*
About: Includes Wifi name and password, memory size of micro SD card, firmware version.

Reset: It can delete all the settings and restore to factory state and restart.

Password Switch: Switch off, it directly enters working state upon startup; switch on, it needs to enter a password to start working. The default startup password is 8888.

WiFi Switch Touch to switch Wifi on or off.

Format Touch and check format micro SD card. Format will delete all the data in micro SD card. Be sure to do a good job of data backup.

Return Touch it to return and exit system setting.

RoadCam APP

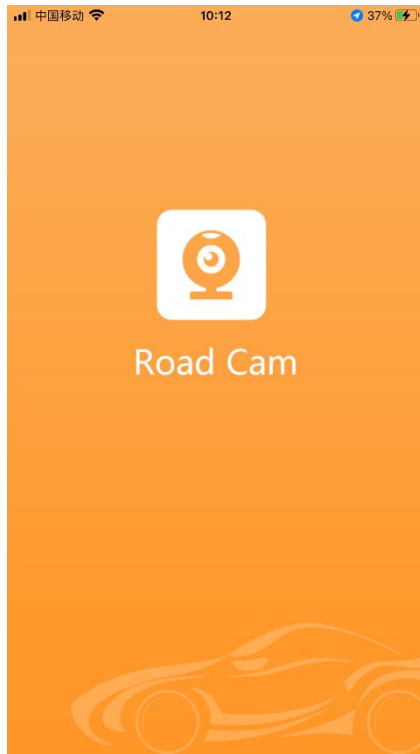

Before run RoadCam App, turn on the Wifi of the monitor first. Find the SSID name and password in "About" . Then add the WiFi network of the monitor to the WiFi configuration of the external device.

APP Monitoring Interface

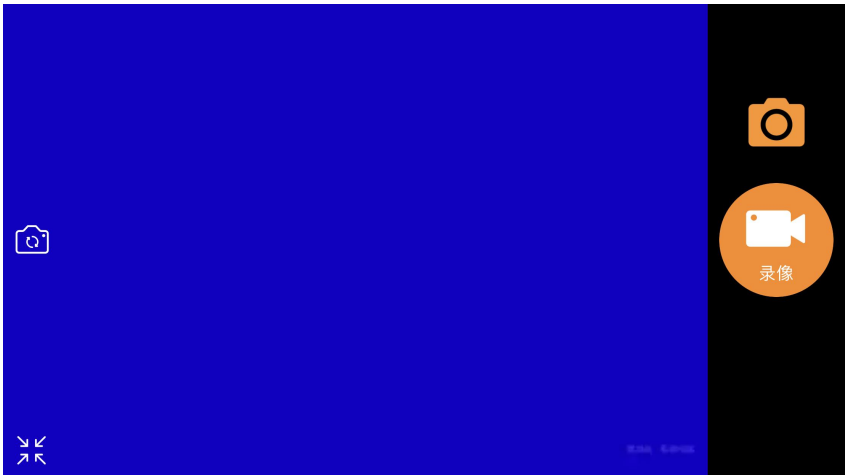

- Run RoadCam App, touch device to connect. After successful connection, it automatically jump to camera interface. You can take photo, recording, play and share.
- You also can change the WiFi name and password in RoadCam Setting.
- Save the photo and recording files to monitor.
- Enter into *Video*, play and load video locally.
- Enter into *Photo*, play and load photo locally.

Charge

Push away the waterproof protective cover. Connect DC12V adapter with DC port, or connect Type-c port with USB-C adapter (user himself provided). During Charging, the indicator is on. When fully charged, the light turns off. It takes about 4 hours to fully charge.

Firmware Upgrade

Before upgrade, please ensure power is >20% (1 grid). Copy upgrade file (Sigmastar Upgrade SD) to micro SD card. Power on, it will auto upgrade. It will auto turn off after upgrade. Unplug card to finish upgrade.

Attention

1. Please use device under temperature between $-20\text{ }^{\circ}\text{C}$ and $60\text{ }^{\circ}\text{C}$. Excessive temperature will cause abnormal expansion, ignition and even explosion of the battery. Before using it under low temperature, it is recommended to fully charge under normal temperature to extend the life of battery.
2. Please place device in a proper position to prevent it from falling and breaking the screen.
3. This machine is dust-proof and rainproof. Please do not immerse the machine in water.
4. If you continue to use the micro SD card on this device after upgrade, please delete the upgrade files.
5. The default startup password is 8888.

Data Port Pin Definition

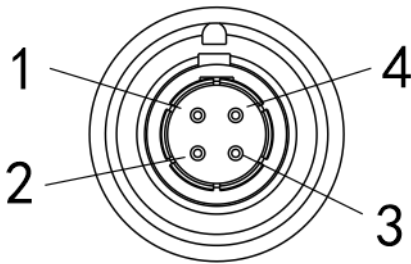
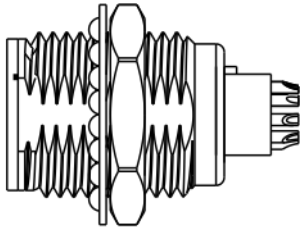

- 1, DC12V**
- 2, Video**
- 3, LED control**
- 4, GND**

Specification

Display	7.0 inch
Screen Resolution	1280*800 px
Touch screen	capacitive touch screen
Video recording	4K(16:9): 3840x2160
	2K(4:3): 2560x1944
	2K(16:9): 2560x1440
	1080p(16:9): 1920X1080
Video input	4K,2K,1080P,720P CVBS PAL, CVBS NTSC
Video format	MP4
Photo	12MP、 8MP、 4MP、 2MP (JPG)
Video Output (16: 9)	HDMI 1080P
Compression mode	H. 264 video compression
Audio input/output	1.0Vp-p (20Hz-20KHz)
Speaker Output	1W
Camera LED Control	PWN
File System Support	FAT32
Memory card	Micro SD card 2GB-256GB
Language	Chinese, English, German, French, Korean, Russian, Japanese, etc.

Specification

WiFi Protocol	802.11 a/b
WiFi Channel	2.4000-2.4835Ghz
WiFi power	<16dBm
Power Supply	DC 12V/2.5A
Lithium battery capacity	5000mAh 37.0Wh
Maximum charging power	15W
Working time	About 6 Hours
Operating temperature	-20°C to 50°C
Waterproof grade	IP65
Size	L*W*H 211*141*28mm
Weight	0.8kg

RoadCam App Download

